

PHILIPS

hue personal
wireless
lighting

Flourish



L
HUE serial number



User manual
Notice d'emploi
Manual de usuario

Incl.

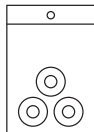
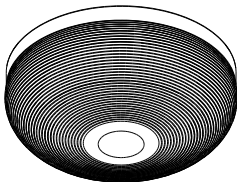

Excl.

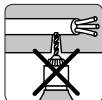
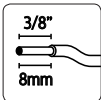
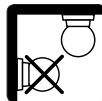
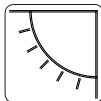
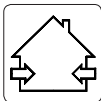
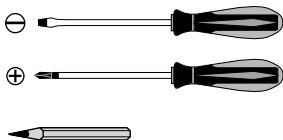
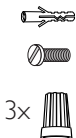
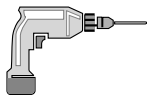

EN IMPORTANT SAFETY INSTRUCTIONS

Product appearance may vary from image shown.

CAUTION - RISK OF FIRE

THIS PRODUCT MUST BE INSTALLED IN ACCORDANCE WITH THE APPLICABLE INSTALLATION CODE BY A PERSON FAMILIAR WITH THE CONSTRUCTION AND OPERATION OF THE PRODUCT AND THE HAZARDS INVOLVED.

DANGER - RISK OF SHOCK - DISCONNECT POWER BEFORE INSTALLATION.

FR MESURES DE SÉCURITÉ À RESPECTER

L'apparence du produit peut différer de l'image montrée.

ATTENTION - RISQUE D'INCENDIE

CE PRODUIT DOIT ÊTRE INSTALLÉ SELON LE CODE D'INSTALLATION PERTINENT? PAR UNE PERSONNE QUI CONNAÎT BIEN LE PRODUIT ET SON FONCTIONNEMENT AINSI QUE LES RISQUES INHÉRENTS.

DANGER - RISQUE DE CHOC - COUPER L'ALIMENTATION AVANT L'INSTALLATION.

ES INSTRUCCIONES DE SEGURIDAD IMPORTANTES

La apariencia del producto puede variar de la imagen mostrada.

PRECAUCION - RIESGO DE INCENDIO

ESTE PRODUCTOR DEBE SER INSTALADO SEGUN EL CODIGO DE INSTALACION APLICABLE POR UNA PERSONA QUE CONOZCA LA CONSTUSSION Y EL FUNCIONAMIENTO DEL PRODUCTO Y LOS RIESGOS QUE SUPONE.

PELIGRO - RIESGO DE DESCARGA ELÉCTRICA - DESCONECTE LA ENERGÍA ANTES DE LA INSTALACIÓN.

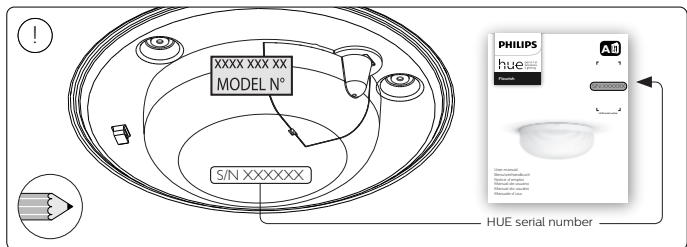
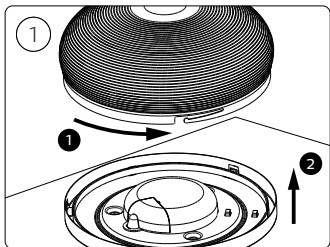
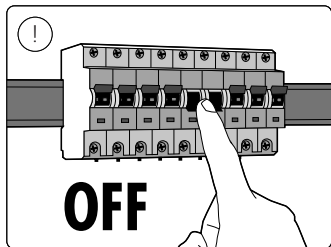

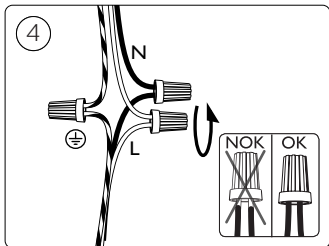
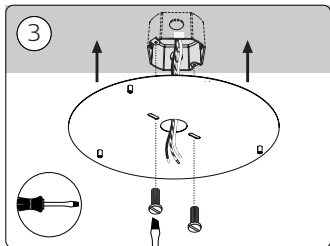
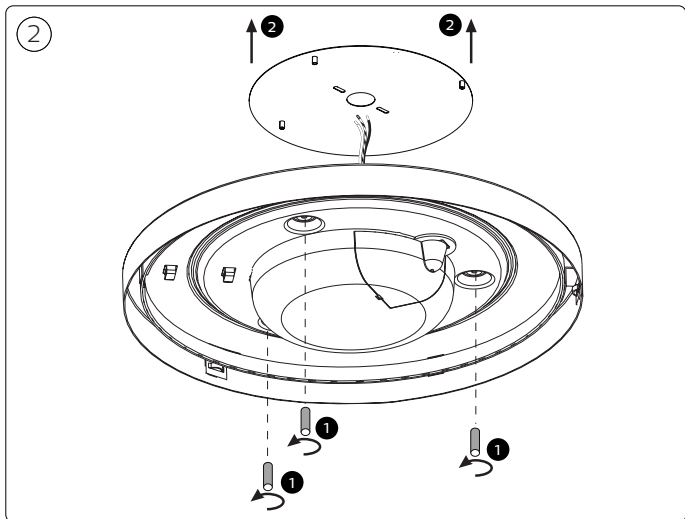

5

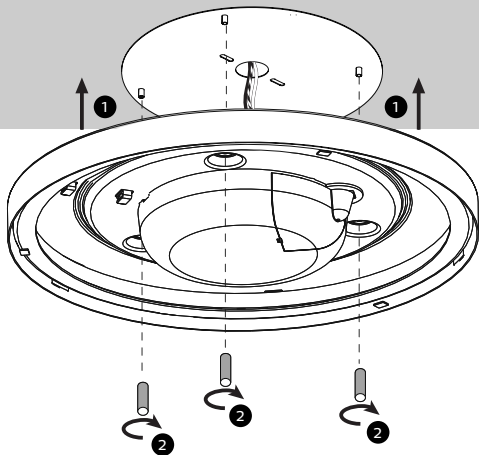

6

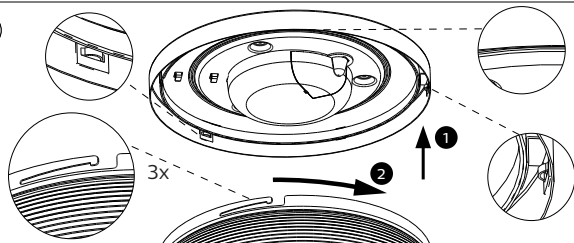

6

7

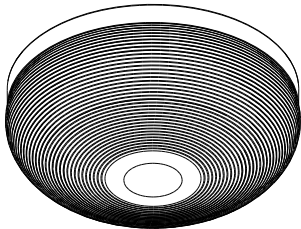

!

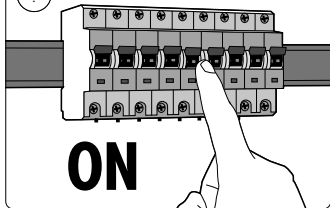

!

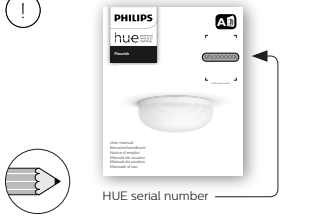

!



!



www.philips-hue.com



Signify North America Corporation
200 Franklin Square Drive
Somerset, NJ 08873, USA

Signify Canada Ltd./Signify Canada Ltée.
281 Hillmount Road,
Markham, ON, Canada L6C 2S3

Questions or Comments / Questions ou commentaires :
1-800-555-0050

Importado y/o distribuido en México por:
Signify Mexico S.A. De C.V.
Av. La Palma No. 6,
La Herradura, Huixquilucan,
Edo de México, C.P. 52784, México –
R.F.C. PME-620620-E84

Centro de contacto:
01-800-508-9000

© 2021 Signify Holding
All rights reserved

www.philips-hue.com

4404 029 10212
Last update: 04/2021